



PV Remote WL
A 1785
Instruction manual
Version 1.1.1, Code no. 20 753 318

Distributor:

Manufacturer:

Metrel d.o.o.
Ljubljanska cesta 77
SI-1354 Horjul
Slovenia
[e-mail:info@metrel.si](mailto:info@metrel.si)
<https://www.metrel.si>

DATA BACKUP AND LOSS:

It is the user's responsibility to ensure the integrity and security of the data carrier and to regularly backup and validate the integrity of backups of the data. METREL HAS NO OBLIGATION OR LIABILITY FOR ANY LOSS, ALTERATION, DESTRUCTION, DAMAGE, CORRUPTION OR RECOVERY OF USER DATA, REGARDLESS OF WHERE THE DATA IS STORED.



Mark on your equipment certifies that it meets requirements of all subjected EU regulations.



Hereby, Metrel d.o.o. declares that the A 1785 is in compliance with Directive 2014/53/EU (RED) and all other subjected EU directive. The full text of the EU declaration of conformity is available at the following internet address <https://www.metrel.si/DoC>.



Mark on your equipment certifies that it meets requirements of all subjected UK regulations.



Hereby, Metrel d.o.o. declares that the A 1785 is in compliance with Radio Equipment Regulations 2017 and all other subjected UK regulations. The full text of the UK declaration of conformity is available at the following internet address <https://www.metrel.si/UK-DoC>.

© Metrel d.o.o.

Published: 01/2024

The trade names Metrel®, Smartec®, Eurotest®, Auto Sequence® are trademarks registered in Europe and other countries.

No part of this publication may be reproduced or utilized in any form or by any means without permission in writing from METREL.

Table of contents

1	Preface	4
1	Safety and operational considerations	5
1.1	Warnings and notes	5
1.2	Battery and charging	5
1.3	Standards applied.....	7
2	Instrument description.....	8
2.1	Front panel	8
2.2	Connector panel	9
2.3	Back side	10
2.4	Battery indication	11
2.5	Warnings and messages	11
2.6	Help screens.....	11
2.7	Backlight and contrast adjustments.....	11
2.8	Measuring probes	12
3	Instrument operation	13
3.1	Function selection	13
3.2	Settings.....	13
3.2.1	Language	13
3.2.2	Communications	14
3.2.3	Clear memory.....	15
3.2.4	Irradiance sensor	15
3.2.5	Temperature sensors.....	16
3.2.6	Date and time	16
4	Measurements	17
5	Saving of results and synchronization with the instrument.....	20
5.1	Synchronization with MI 3108 / MI 3109 instruments	20
5.2	Synchronization with MI 3114 / MI 3115 instruments	21
6	Upgrading the instrument	22
7	Maintenance.....	23
7.1	Periodic calibration.....	23
7.2	Service.....	23
7.3	Cleaning.....	23
8	Technical specifications.....	24
8.1	Irradiance.....	24
8.2	Temperature (cell and ambient).....	24
8.3	General data (PV Remote WL)	24

1 Preface

The PV Remote WL is a professional hand-held accessory intended to perform temperature and solar irradiance measurements.

PV modules and connection terminals for measuring are often not on the same location. For examples PV modules are on the roof and connection terminals are at the inverter, inside the building. With the PV Remote WL, environmental parameters can be measured while electrical parameters are measured with the instrument on another location. The clocks of main instrument and PV Remote WL can be synchronized. This enables an easy pooling of data measured at the same time after the tests are finished.

Contemporary measurement of electrical and environmental values is demanded in some standards for calculation of efficiency of PV systems.

The graphic display with backlight offers easy reading of results, indications, measurement parameters and messages.

1 Safety and operational considerations

1.1 Warnings and notes

In order to maintain a high level of accuracy while carrying out various tests and measurements, Metrel recommends keeping your PV Remote WL in good condition and undamaged. When using the instrument, consider the following general warnings:

- ❑ The  symbol on the instrument means »Read the Instruction manual with special care for safe operation«. The symbol requires an action!
- ❑ Service intervention or adjustment is only allowed to be carried out by competent authorized personnel!
- ❑ The instrument comes supplied with rechargeable or Ni-MH battery cells. The cells should only be replaced with the same type as defined on the battery compartment label or as described in this manual. Do not use standard alkaline battery cells while the power supply adapter is connected, otherwise they may explode!

1.2 Battery and charging

The instrument uses six AA size alkaline or rechargeable Ni-MH battery cells. Nominal operating time is declared for cells with nominal capacity of 2100 mAh. Battery condition is always displayed in the lower right display part. In case the battery is too weak the instrument indicates this as shown in figure 2.1. This indication appears for a few seconds and then the instrument turns itself off.

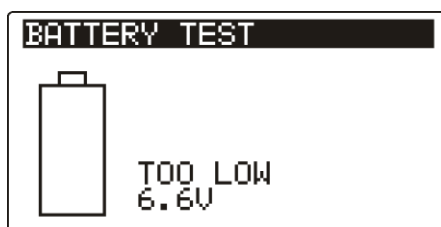

Figure 1-1: Discharged battery indication

The battery is charged whenever the power supply adapter is connected to the instrument. The power supply socket polarity is shown in figure 2.2. Internal circuit controls charging and assures maximum battery lifetime.



Figure 1-2: Power supply socket polarity

The instrument automatically recognizes the connected power supply adapter and begins charging.

Symbols:



Figure 1-3: Charging indication

Warnings related to safety

- ❑  When connected to an installation, the instruments battery compartment can contain hazardous voltage inside! When replacing battery cells or before opening the battery/fuse compartment cover, disconnect any measuring accessory connected to the instrument and turn off the instrument,
- ❑ Ensure that the battery cells are inserted correctly otherwise the instrument will not operate and the batteries could be discharged.
- ❑ If the instrument is not to be used for a long period of time, remove all batteries from the battery compartment.
- ❑ Alkaline or rechargeable Ni-MH batteries (size AA) can be used. Metrel recommends only using rechargeable batteries with a capacity of 2100mAh or above.
- ❑ Do not recharge alkaline battery cells!
- ❑ Use only power supply adapter delivered from the manufacturer or distributor of the test equipment to avoid possible fire or electric shock!

Notes:

- ❑ The charger in the instrument is a pack cell charger. This means that the battery cells are connected in series during the charging. The battery cells have to be equivalent (same charge condition, same type and age).
- ❑ One different battery cell can cause an improper behavior of the entire battery pack.
- ❑ Unpredictable chemical processes can occur during the charging of battery cells that have been left unused for a longer period (more than 6 months). In this case Metrel recommends to repeat the charge / discharge cycle at least 2-4 times.
- ❑ If no improvement is achieved after several charge / discharge cycles, then each battery cell should be checked (by comparing battery voltages, testing them in a cell charger, etc). It is very likely that only some of the battery cells are deteriorated.
- ❑ The effects described above should not be confused with the normal decrease of battery capacity over time. Battery also loses some capacity when it is repeatedly charged / discharged. This information is provided in the technical specification from battery manufacturer.

1.3 Standards applied

The instrument is manufactured and tested according to the following regulations, listed below.

Electromagnetic compatibility (EMC)

EN 61326-1 Electrical equipment for measurement, control and laboratory use - EMC requirements – Part 1: General requirements

EN 61326-2-2 Electrical equipment for measurement, control and laboratory use - EMC requirements – Part 2-2: Particular requirements - Test configurations, operational conditions and performance criteria for portable test, measuring and monitoring equipment used in low-voltage distribution systems

Safety (LVD)

EN 61010-1 Safety requirements for electrical equipment for measurement, control, and laboratory use – Part 1: General requirements

Functionality

EN 62466-1 Photovoltaic (PV) systems. Requirements for testing, documentation and maintenance – Part 1: Grid connected systems – Documentation, commissioning tests and inspection

EN 62466-2 Photovoltaic (PV) systems. Requirements for testing, documentation and maintenance. Grid connected systems. Maintenance of PV systems

Note about EN and IEC standards:

- Text of this manual contains references to European standards. All standards of EN 6XXXX (e.g. EN 61010) series are equivalent to IEC standards with the same number (e.g. IEC 61010) and differ only in amended parts required by European harmonization procedure.

2 Instrument description

2.1 Front panel



Figure 2-1: Front panel

Legend:

1	LCD	128 x 64 dots matrix display with backlight.
2	TEST	Starts / stops measurements.
3	UP/ DOWN	Modifies selected parameter.
4	Function selectors	Selects test function
5	HELP	Help screens.
6	Backlight, Contrast	Changes backlight level and contrast.
7	ON / OFF	Switches the instrument power on or off. <i>The instrument automatically turns off 15 minutes after the last key was pressed.</i>
8	MEM	No function in this version
9	TAB	No function in this version

2.2 Connector panel

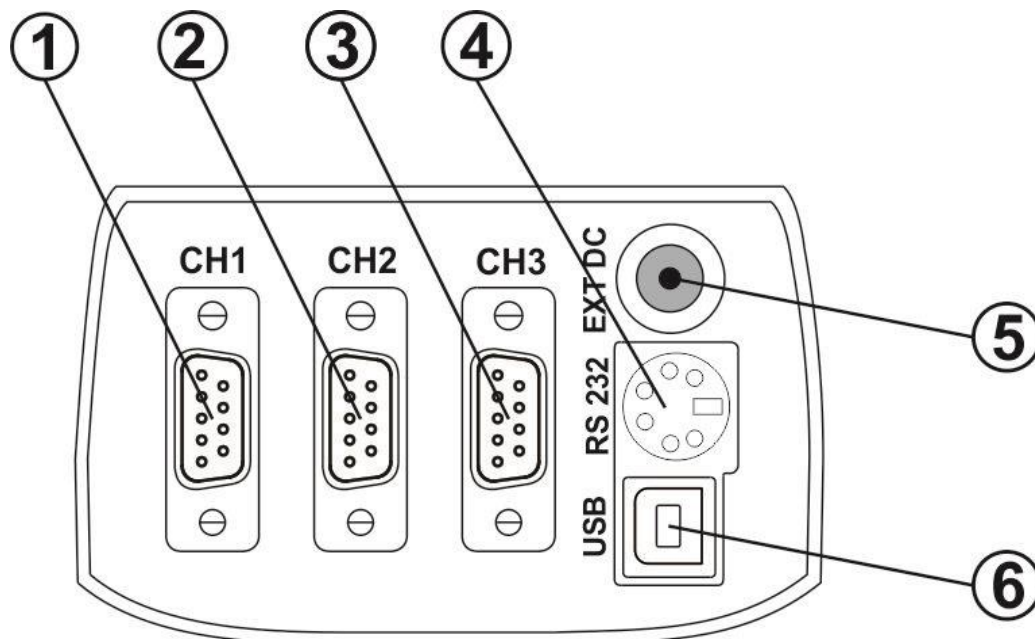

Figure 2-2: Connector panel

Legend:

1	Input 1	Input for measuring Irradiance
2	Input 2	Input for measuring Ambient / Cell temperature
3	Input 3	Input for measuring Cell temperature
4	PS/2 connector	Connection to the measuring instrument Connection to the wireless adaptor
5	Charger socket	
6	USB connector	No function in this version.

Warnings!

- ❑ Maximum short-term voltage of external power supply adapter is 14 V!
- ❑ Maximum short-term voltage on measuring inputs is 12 V!

2.3 Back side



Figure 2-3: Back side

Legend:

- | | |
|---|--|
| 1 | Side belt |
| 2 | Battery compartment cover |
| 3 | Fixing screw for battery compartment cover |
| 4 | Back panel information label |
| 5 | Holder for inclined position of the instrument |





Figure 2-4: Battery compartment

Legend:

- | | | |
|---|---------------------|---|
| 1 | Battery cells | Size AA, alkaline or rechargeable NiMH / NiCd |
| 2 | Serial number label | |

2.4 Battery indication

The indication indicates the charge condition of battery and connection of external charger.

	Battery capacity indication.
	Low battery. Battery is too weak to guarantee correct result. Replace or recharge the battery cells.
	Recharging in progress (if power supply adapter is connected).

2.5 Warnings and messages

In the message field warnings and messages are displayed.

	Measurement is running, consider displayed warnings.
---	--

2.6 Help screens

HELP	Opens help screen.
------	--------------------

The Help menu contains diagrams for illustrating how to properly connect the probes and instrument.

Keys in help menu:

UP / DOWN	Selects next / previous help screen.
Function selectors / HELP	Exits help menu.

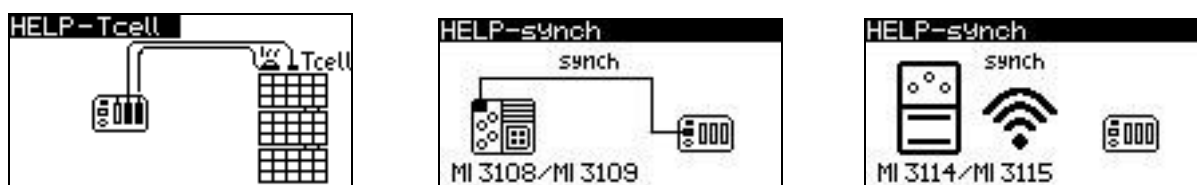

Figure 2-5: Examples of help screens

2.7 Backlight and contrast adjustments

With the BACKLIGHT key backlight and contrast can be adjusted.

Click	Toggles backlight intensity level.
Keep pressed for 1 s	Locks high intensity backlight level until power is turned off or the key is pressed again.

Keep pressed for 2 s Bargraph for LCD contrast adjustment is displayed.



Figure 2-6: Contrast adjustment menu

Keys for contrast adjustment:

DOWN	Reduces contrast.
UP	Increases contrast.
TEST	Accepts new contrast.
Function selectors	Exits without changes.

2.8 Measuring probes

List of compatible measuring probes is available on request from your distributor.

3 Instrument operation

3.1 Function selection

For selecting main functions the FUNCTION SELECTOR shall be used.

Keys

FUNCTION SELECTOR	Select function: <ul style="list-style-type: none"> ▪ <SOLAR> Measurements ▪ <SETTINGS> Instrument settings
-------------------	---

3.2 Settings

In the SETTINGS menu:

- language can be selected,
- communication with PV instrument can be configured/established,
- memory can be cleared,
- irradiance sensor can be configured and
- ambient temperature or second cell temperature can be configured.

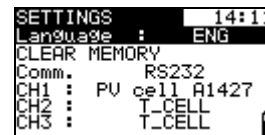

Figure 3-1: Options in Settings menu

Keys

UP / DOWN	Selects option.
TEST	Enters menu for selecting parameter.

3.2.1 Language

In this menu the language can be set.

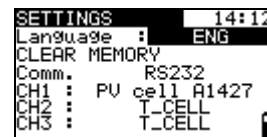

Figure 3-2: Language selection

Keys

UP / DOWN	Selects language.
TEST	Confirms selected language.

3.2.2 Communications

In this menu communication can be established with PV instrument.

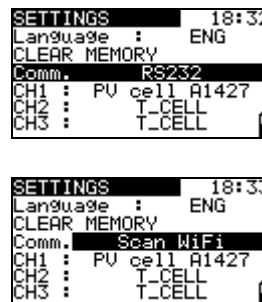

Figure 3-3: Communication screen

Parameters

Comm.	<p>Communication port [RS232, Reset WiFi, Scan WiFi, BACK] [RS232]: Communication port used only with MI 3108 and MI 3109 instruments. [Reset WiFi]: Wi-Fi module initialized to factory settings. [Scan WiFi]: Communication with MI 3114 and MI 3115 instruments configured/established. When Wi-Fi configured with selected MI3115 or MI3114 instrument, serial number of the instrument is displayed, e. g. MI3115-22110167. [BACK]: Return to menu without saving configuration.</p>
-------	--

Keys

UP / DOWN	Selects communication option.
TEST	Confirms selected use.

Procedure to establish Wi-Fi communication with MI 3114 / MI 3115 PV instrument

Select **SETTINGS** menu using the function selector switch.

Select Comm. option and press the TEST key.

Select Scan WiFi option and press the TEST key.

PV Remote WL will start searching for Wi-Fi PV instrument(s). After device is found the PV Remote WL will automatically connect to the PV instrument.

If more PV instruments are found, user can select one from the list (with UP or DOWN keys) and connect it with PV Remote WL by pressing the TEST key.

PV Remote WL is now ready to use Wi-Fi communication with PV instrument.

Note

- Modification of Comm. settings will reset previous settings. Wi-Fi scan should be performed again if communication port is switched to RS232 and then back to Wi-Fi.

Procedure to establish RS-232 communication with MI 3108 / MI 3109 PV instrument

Select **SETTINGS** menu using the function selector switch.

Select Comm. option and press the TEST key.

Select RS232 option and press the TEST key.

PV Remote WL is now ready to use wired RS-232 communication with PV instrument.

3.2.3 Clear memory

In this menu data logs can be cleared.

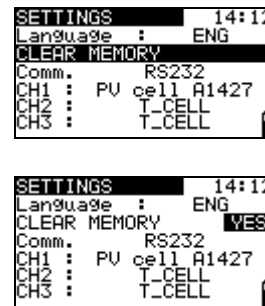

Figure 3-4: Clear memory screens

Keys

UP / DOWN	Selects option.
TEST	YES: Confirms memory clear. NO: Returns to setting menu without memory clear.

3.2.4 Irradiance sensor

In this menu the type of irradiance sensor can be set.

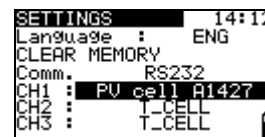

Figure 3-5: Irradiance sensor selection

Parameters

CH1	Irradiance sensor [PV cell A1427, PV cell A1834, Pyran. A1399] - PV cell A 1427: measuring monocrystal PV cell - PV cell A 1834: measuring monocrystal PV cell - Pyran. A 1399: pyranometer
-----	--

Keys

UP / DOWN	Selects type of irradiance sensor.
TEST	Confirms selected use.

3.2.5 Temperature sensors

In this menu the use of temperature sensor on Channel 2 can be set.



Figure 3-6: Use of temperature sensor selection

Parameters

CH2	Temperature sensor [T_CELL, T_AMB]
CH3	Temperature sensor [T_CELL]

Keys

UP / DOWN	Selects use of temperature sensor (Ambient or Cell temperature).
TEST	Confirms selected use.

Notes

- A 1400 and A 1833 temperature sensors are supported.
- If the temperature sensor on Channel 2 is set as a Cell sensor the mean value of both cell sensors (on Channel 2 and Channel 3) will be considered as the Cell temperature in the instrument.
- Use of two cell temperature sensors can improve the accuracy of the measured cell temperatures and calculated STC results.

3.2.6 Date and time

Time is displayed in the upper right part of the LCD.

Refer to chapter *Synchronization* on MI 3115, MI 3114, MI 3108 and MI 3109 Instruction manuals for more information.

4 Measurements

The following environmental measurements can be performed with the PV Remote WL:

- Solar irradiance
- Ambient temperature
- Cell temperature (using single sensor or two sensors)

Temperature and solar irradiance must be measured:

- for calculation of nominal PV values at standard conditions.
- for conversion of solar to electric power of the PV panels.
- to check that environmental conditions are proper for carrying out the PV tests

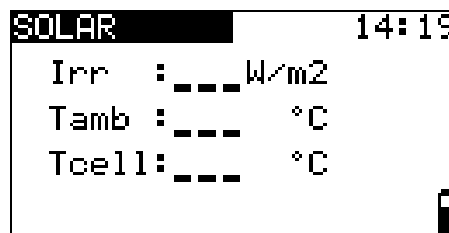

Figure 4-1: Measuring menu

Connections for measurement of environmental parameters

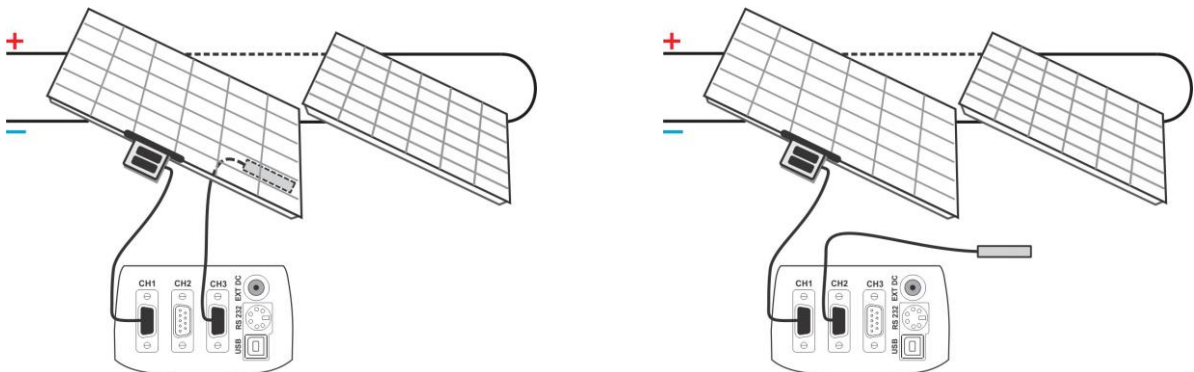

Figure 4-2: Measurement of environmental parameters (Connection of probes)

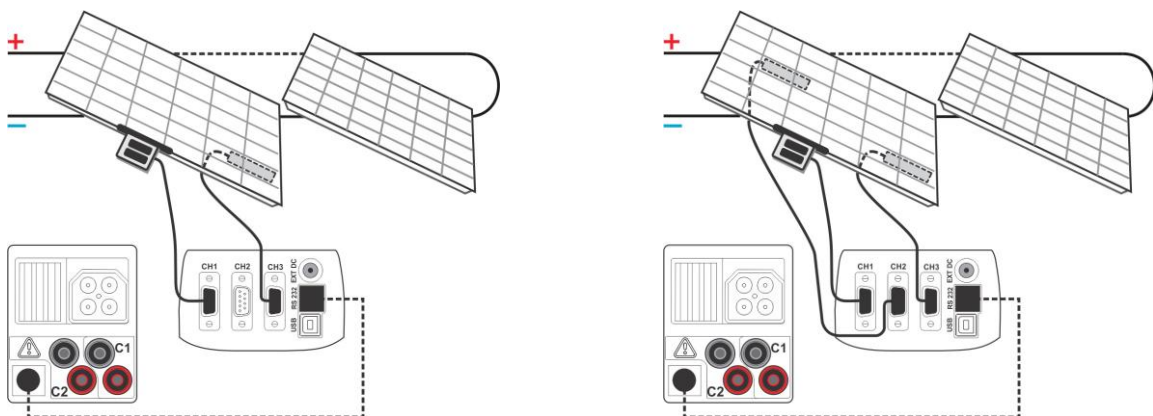

Figure 4-3: Measurement of environmental parameters (Connections to MI 3108 or MI 3109)

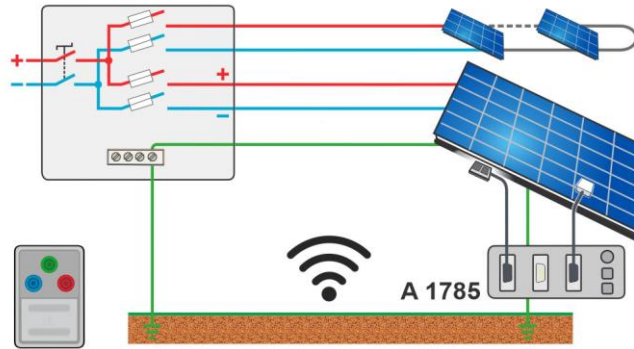

Figure 4-4: Measurement of environmental parameters (Connections to MI 3114 or MI 3115)

Procedure for measuring of environmental parameters

Select **SOLAR** function using the function selector switch.

Connect environmental probes to the PV Remote WL.

Connect the probes to the item to be tested (see figure 5.2).

Connect the PV Remote WL to the instrument (optional)

Press the TEST key to start the measurement.

Press the TEST key to stop the measurement.

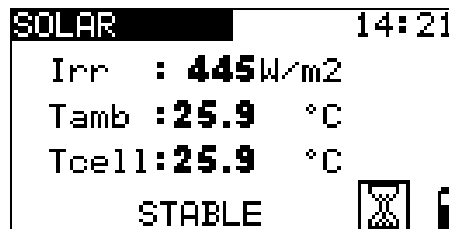

Figure 4-5: Example of results – measurement

Test results / sub-results

Irr	Irradiance at time of measurement
Tcell	PV cell temperature at time of measurement
Tamb	Ambient temperature at time of measurement

Notes

- If PV Remote WL is connected with the instrument the measured data are sent to the instrument. For more information about this feature refer to MI 3108 / MI 3109 and MI 3114 / MI 3115 Instruction Manual.

- If the temperature sensor on Channel 2 is set as a Cell sensor the mean value of both cell sensors (on Channel 2 and Channel 3) will be considered as the Cell temperature in the instrument.

5 Saving of results and synchronization with the instrument

The measured results and time of measurement are automatically stored into the PV Remote WL's memory.

After the measurement the stored results can be synchronized with results in the instrument MI 3108 / MI 3109 or MI 3114 / MI 3115 that were measured at the same time. The instrument can then calculate correct STC values.

Before the measurements the time and date between the instrument and Remote WL should be synchronized. For more information about this feature refer to *MI 3108, MI 3109, MI 3114 or MI 3115 Instruction manuals*.

5.1 Synchronization with MI 3108 / MI 3109 instruments

For time and results synchronization, RS232 communication should be established first. Refer to paragraph 3.2.2 *Communications*.

For time and results synchronization, the RS232 port on the instrument MI 3108 / MI 3109 must be connected with the RS232 port on the PV Remote WL. Use the PS/2 to RS232 (female) data cable delivered with the MI 3108 / MI 3109 and the RS232 (male) to PS/2 cable adapter delivered with A 1785.

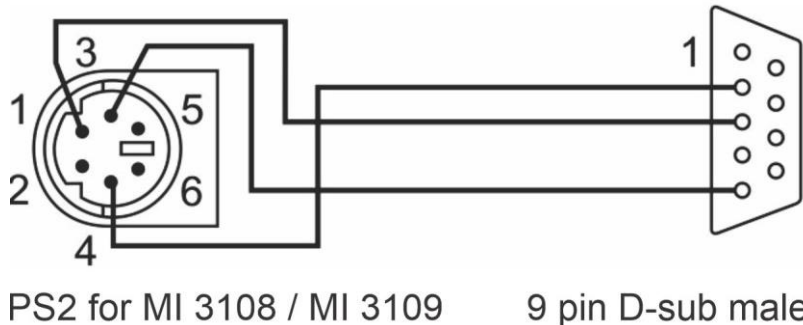

Figure 5-1: Interface connection for the RS232 (male) to PS/2 cable adapter

Connection for synchronization

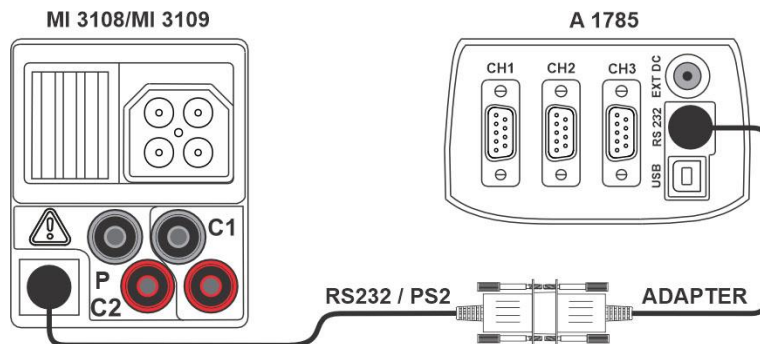

Figure 5-2 Connection of the instruments during synchronization

5.2 Synchronization with MI 3114 / MI 3115 instruments

For time and results synchronization with MI 3114 / MI 3115 PV instrument, Wi-Fi communication should be used on the PV Remote WL. Refer to paragraph 3.2.2 *Communications* to establish Wi-Fi communication with the PV instrument.

Actual environmental data are sent to the PV instrument during the test if Wi-Fi communication between PV Remote WL and PV instrument is active and PV instrument request for them.

6 Upgrading the instrument

The instrument can be upgraded from a PC via the RS232 communication port. This enables to keep the instrument up to date even if the standards or regulations change. Please contact your dealer for more information.

Note

- To upgrade firmware, the RS232 communication port should be configured first. Refer to to paragraph 3.2.2 *Communications* for detailed information.

7 Maintenance

Unauthorized persons are not allowed to open the PV Remote WL. There are no user replaceable components inside the instrument, except the battery under rear cover.

7.1 Periodic calibration

It is essential that all measuring instruments are regularly calibrated for the technical specification listed in this manual to be guaranteed. We recommend an annual calibration.

7.2 Service

For repairs under or out of warranty please contact your distributor for further information. Unauthorized person is not allowed to open the instrument. There are no user replaceable parts inside the instrument.

7.3 Cleaning

No special maintenance is required for the housing. Use a soft, slightly moistened cloth with soap water or alcohol to clean the surface of the instrument. Leave the instrument to dry totally before using it.

WARNING

- Do not use liquids based on petrol or hydrocarbons!
- Do not spill cleaning liquid over the instrument!

8 Technical specifications

8.1 Irradiance

Probe A 1399

Measuring range (W/m ²)	Resolution (W/m ²)	Accuracy
300 ... 999	1	± (5 % + 5 digits)
1.00 k ... 1.75 k	10	± 5 %

Measuring principle: Pyranometer

Operation conditions:

Working temperature range -40 °C ... 55 °C

Designed for continuous outdoor use.

Probes A 1427 and A 1834

Measuring range (W/m ²)	Resolution (W/m ²)	Accuracy
300 ... 999	1	± (4 % + 5 digits)
1.00 k ... 1.75 k	10	± 4 %

Measuring principle: Monocrystall PV cell, temperature compensated

Operation conditions:

Working temperature range -20 °C ... 55 °C

Protection degree IP 44

8.2 Temperature (cell and ambient)

Probes A 1400 and A 1833

Measuring range (°C)	Resolution (°C)	Accuracy
-10.0 ... 85.0	0.1	± 5 digits

Designed for continuous outdoor use.

8.3 General data (PV Remote WL)

Power supply voltage..... 9 V_{DC} (6×1.5 V battery or accu, size AA)

Operation typical 11 h

Charger socket input voltage 12 V ± 10 %

Charger socket input current 400 mA max.

Battery charging current	250 mA (internally regulated)
Protection degree	IP 40
RS232 Baud rate.....	9600
Wi-Fi	802.11 b/g/n (802.11n up to 150 Mbps) (Only for communication with Metrel PV testers)

Number of memorized results: > 3000, circular buffer

In case the instrument gets moistened, the results could be impaired. In such case, it is recommended to dry the instrument and accessories for at least 24 hours.

The error in operating conditions could be at most the error for reference conditions (specified in the manual for each function) ± 5 % of measured value.

Display 128x64 dots matrix display with backlight.

Dimensions (w × h × d) 14 cm × 8 cm × 23 cm

Weight 1.0 kg, without battery cells

Reference conditions

Reference temperature range..... 10 °C ... 30 °C

Reference humidity range 40 %RH ... 70 %RH

Operation conditions

Operation Outdoor use

Working temperature range 0 °C ... 40 °C

Maximum relative humidity 95 %RH (0 °C ... 40 °C), non-condensing

Storage conditions

Temperature range..... -10 °C ... +70 °C

Maximum relative humidity 90 %RH (-10 °C ... +40 °C)

80 %RH (40 °C ... 60 °C)

ROTEC

ROTEC Vertriebsgesellschaft
für Elektrotechnik mbH

Jurastraße 5
73119 Zell u.A.
Deutschland

T +49 (0) 7164 903 402-0
F +49 (0) 7164 903 402-39
info@rotec-gmbh.com
www.rotec-gmbh.com

Immer
gut beraten.